



## OE8113/OP2 - Lincat Opus 800 Electric Free-standing Twin Tank Fryer with Pumped Filtration - 2 Baskets - W 600 mm - 24.0 kW

An accurate Opus 800 Twin-Tank Free Standing Electric Fryer which comes with two independent fryer tanks for greater versatility and a twin-pumped oil filter system.

- ✔ Two independent fryer tanks for greater versatility
- ✔ Accurate thermostatic control up to 190°C for consistent results and safe operation
- ✔ Pumped oil return enables the oil to be filtered and the fryer ready for use again in less than five minutes - safe and convenient
- ✔ Oil can be filtered during or after service even whilst hot
- ✔ Hinged, lift out element, with safety interlock for easy tank access and cleaning

### Specifications

#### Summary

<b>Brand</b>	Lincat
<b>Range</b>	Opus 800
<b>Power Type</b>	Electric
<b>Unit Type</b>	Free-standing
<b>Available in UK Only</b>	No
<b>UK Warranty</b>	2 Years Parts and Labour Warranty
<b>Export Warranty</b>	Contact your local dealer
<b>GTIN</b>	5056105102984

#### Power and Performance

<b>Total Power kW</b>	24.0
<b>Temperature Range °C</b>	90-190
<b>IP Rating</b>	IP24
<b>Temperature Control</b>	Mechanical

#### Key Specifications

<b>Number of Baskets</b>	2
<b>Number of Tanks</b>	2
<b>Gravity Filtration</b>	No
<b>Pumped Filtration</b>	Yes
<b>Drain Location</b>	Through the body

#### Capacity

<b>Product Output per Hour</b>	64kg chips - 12mm [frozen], 84kg chips - 12mm [chi]
<b>Capacity Litres</b>	2 x 15.0

#### Weights and Dimensions

<b>Unit Height (External) mm</b>	1070
<b>Unit Width (External) mm</b>	600
<b>Unit Depth (External) mm</b>	800
<b>Net Weight Kg</b>	118

#### Supply Connections

<b>Requires Installation</b>	Yes
<b>Requires Electrical Supply</b>	Yes
<b>UK 3 Pin Plug</b>	No
<b>Requires Hardwiring</b>	Yes
<b>Electrical Supply Rating Watts</b>	24,000
<b>Three Phase Amps</b>	L1/L2/L3= 34.8 [1 cab]; L1/L2/L3= 2 x 17.4 [2 cab]
<b>Three Phase Voltage</b>	400

#### Shipping

<b>Packed Weight Kg</b>	129.8
<b>Packed Height cm</b>	122
<b>Packed Width cm</b>	70
<b>Packed Depth cm</b>	85

### Available Accessories

LK02

Product Code: OE8113/OP2

NP1 IS.350 I FR KIT

Page Number: 1

Print Date: 12/01/2023

Available Accessories

OA8954

SPLASHGUARD FOR OPUS 800 ELECTRIC FRYERS

Technical Picture

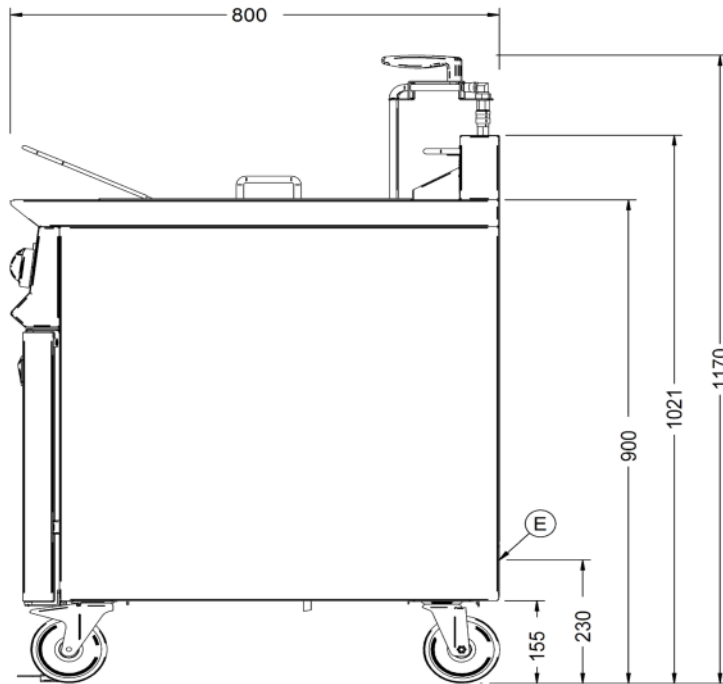
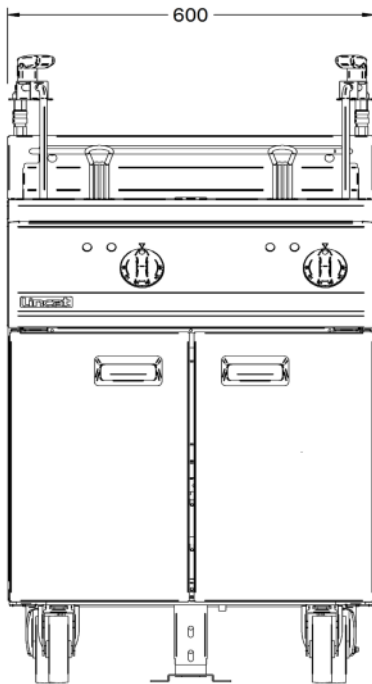
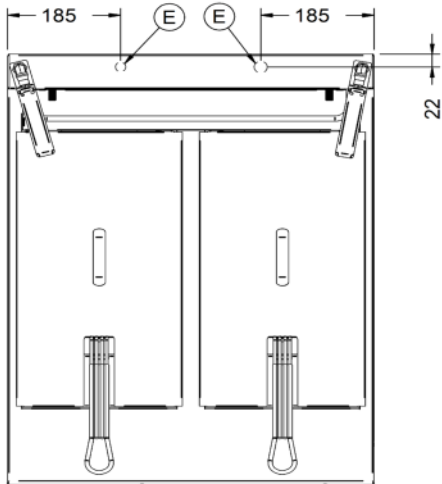



**Lincat Limited**

Whisby Road,  
Lincoln, LN6 3QZ,  
United Kingdom

**Company No:** 2175448

A member company of



**Customer Care**

**Tel:** +44 1522 875500  
**Email:** care@lincat.co.uk

**Export Customers**

**Tel:** +44 1522 875536  
**Email:** export@lincat.co.uk

**Opening Hours**

**Monday – Friday:**  
8.30am – 5pm